

Qualiton A35
User's Manual

CONTENTS

IMPORTANT SAFETY INSTRUCTIONS.....	4
MARKINGS	8
PREFACE	9
BASIC INFORMATION.....	10
TECHNICAL ASSISTANCE AND SERVICE INFORMATION ...	11
GENERAL SPECIFICATIONS.....	12
ELECTRICAL SPECIFICATIONS	13
FRONT PANEL.....	14
REAR PANEL.....	16
CONTENTS OF PACKAGE.....	18
PLACEMENT.....	19
INSTALLATION OF VACUUM TUBES.....	20
USING THIRD PARTY VACUUM TUBES	23
BLOCK DIAGRAM	24
CONNECTION DIAGRAM	25
AC MAINS CONNECTION	26
GOOD TO KNOW.....	27
REMOTE CONTROL	28
INSERTING / REPLACING BATTERY	29
REPLACEMENT OF FUSE	30
WASTE MANAGEMENT	31

IMPORTANT SAFETY INSTRUCTIONS

PLEASE READ THEM BEFORE OPERATING THIS EQUIPMENT!



1. Read these instructions.
2. Keep these instructions.
3. Heed all warnings.
4. Follow all instructions.
5. Improper installation may cause malfunction!
6. Do not use this apparatus near water.
7. Clean only with a dry cloth.
8. Do not block any ventilation openings since this may lead to fire. Install in accordance with the manufacturer's instructions.
9. Do not install near any heat sources such as radiators, heat registers, stoves, or other apparatus (including amplifiers) that produce heat.
10. Do not defeat the safety purpose of the polarized or grounding-type plug. A polarized plug has two blades with one wider than the other. A grounding type plug has two blades and a third grounding prong. The wide blade or the third prong are provided for your safety. If the provided plug does not fit into your outlet, consult an electrician for replacement of the obsolete outlet.
11. Connect mains power supply cord only to a mains socket outlet with a protective earthing connection.

IMPORTANT SAFETY INSTRUCTIONS

12. Be careful with appliance cables! Do not lead them across sharp surfaces, do not clamp them together and do not leave them in a hanging position.

Protect the power cord from being walked on or pinched particularly at plugs, convenience receptacles, and the point where they exit from the apparatus.

13. You must not operate the appliance with damaged cables.

14. Before powering up your amplifier, make sure protective cover, ports, plugs and cables are checked for intactness.

15. Only use attachments/accessories specified by the manufacturer.

16. Use only with the cart, stand, tripod, bracket, or table specified by the manufacturer, or sold with the apparatus. When a cart is used, use caution when moving the cart/apparatus combination to avoid injury from tip-over.



17. Unplug this apparatus during lightning storms or when unused for long periods of time.

18. **No user-serviceable parts inside. Improper repair may lead to loss of warranty! Refer servicing to qualified service personnel.**

IMPORTANT SAFETY INSTRUCTIONS

PLEASE READ THEM BEFORE OPERATING THIS EQUIPMENT!



19. Servicing is required when the apparatus has been damaged in any way, such as power supply cord or plug is damaged, liquid has been spilled or objects have fallen into the apparatus, the apparatus has been exposed to rain or moisture, does not operate normally, or has been dropped.
20. You must not start up damaged or faulty appliance. In case of any malfunction, unplug your amplifier immediately.
21. In case of a malfunction, the protective cover must not be opened or removed.
22. Do not expose this equipment to dripping or splashing and ensure that no objects filled with liquids, such as vases, are placed on the equipment.
23. Do not touch the appliance or its mains cable with wet hands.
24. In case of fire, you must not use water to extinguish the fire, even if the amplifier is switched off.
25. The appliance may only be used by qualified adults or children above 14 years of age if supervised by a qualified adult.
26. Keep the appliance out of the reach of children.
27. Make sure your domestic animal does not lie or sit on the top of the appliance.
28. If you do not use your amplifier for a long time, unplug the appliance carefully.

IMPORTANT SAFETY INSTRUCTIONS



29. To completely disconnect this equipment from the AC mains, disconnect the power supply cord plug from the AC receptacle.

30. The mains plug of the power supply cord shall remain readily operable.

31. Do not expose batteries to excessive heat such as sunshine, fire or the like.

32. **WARNING!** To reduce risk of fire or electrical shock, do not expose this equipment to rain or moisture.

33. **CAUTION!** To reduce the risk of electric shock, do not remove cover.

MARKINGS



The exclamation point within an equilateral triangle is intended to alert the user to the presence of important operating and maintenance instructions in the literature accompanying the appliance.



CAUTION: Hot Surface! Do Not Touch!
Protective cover of the product may become hot when operating this product continuously.



The crossed-out wheeled bin is the European Union symbol for indicating separate collection for electrical and electronic equipment. This product contains electrical and electronic equipment which should be reused, recycled or recovered and should not be disposed of with unsorted regular waste. Please return the unit or contact the authorised dealer from whom you purchased this product for more information.



The product meets the relevant directives and standards of the European Union.



Supplied with alternating current (AC).

115 V / 230 V Nominal supply voltage.

50 Hz / 60 Hz Nominal supply frequency.

PREFACE

Before installing the Qualiton A35 stereo amplifier, please study this User's Manual carefully!

Operating your amplifier in a manner it is designed for, ensures you an utmost musical experience and a reliable operation.

If you have any questions on our products or services, please do not hesitate to contact us on our website www.audiohungary.com

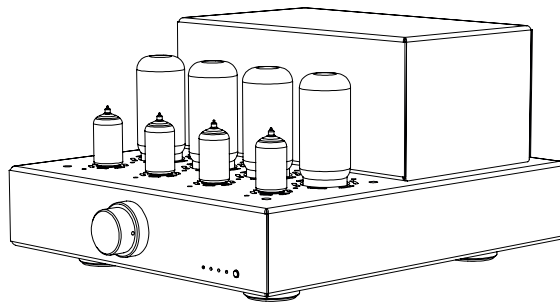

BASIC INFORMATION

For your convenience, please fill out the following lines to facilitate any future technical assistance and repair service:

Serial Number:

Date of purchase:

Dealer Name:

Vacuum tubes used:

TECHNICAL ASSISTANCE AND SERVICE INFORMATION

If at any time you have any questions about your Qualiton product, do not hesitate to contact your local Qualiton dealer, who is at your disposal. If you or your dealer need more help, you can receive technical assistance at:

Audio-Hungary Ltd.
132 Derkovits Street
4400, Nyíregyháza, Hungary
Phone: +36 42 446-688
Fax: +36 42 446-688
E-mail: infox@audiohungary.hu

If it becomes clear that your Qualiton product needs service, you should still contact your local dealer first. You can also contact us directly for more instructions at one of the contact details above.

GENERAL SPECIFICATIONS

Number of input ports / channel	3 unbalanced Stereo IN
	1 balanced Stereo IN
Number of output ports / channel	1 unbalanced Power OUT
Tubes required	4 x 7581A
	2 x 12AX7
	2 x 6922
Weight	15 kg
Dimensions	29 x 37 x 19 cm
Power requirement	idle: 150 W, max: 300 W

ELECTRICAL SPECIFICATIONS

Rated output power	2 x 35 W
Input impedance, Balanced Stereo IN	40 kOhm
Input impedance, Unbalanced Stereo IN	10 kOhm
Input sensitivity, Balanced Stereo IN	500 mV, to rated output
Input sensitivity, Unbalanced Stereo IN	500 mV, to rated output
Gain	+30 dB (RL = 8 Ohm)
Frequency response	22 Hz to 80 kHz (-3 dB, rated output)
Total Harmonic Distortion	< 0,3% (f = 1 kHz, rated output)
Signal-to-noise ratio	> 98 dB (RL = 8 Ohm, rated output)
Load impedance	4 - 8 Ohm

FRONT PANEL

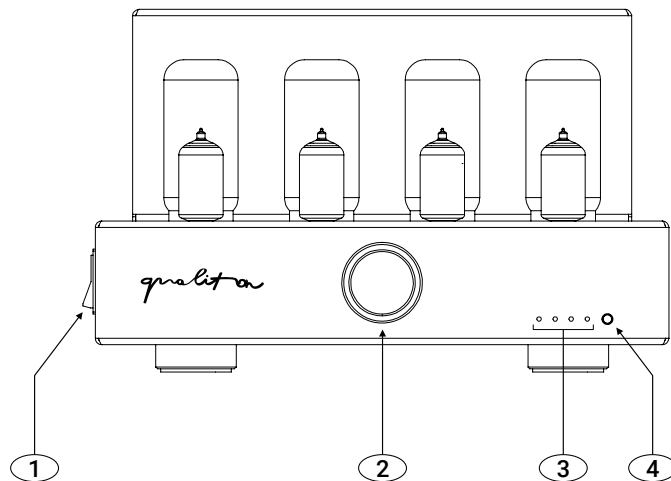

FRONT PANEL

1. MAIN SWITCH with position indicator
2. VOLUME control allows adjustment of the stereo listening level
3. INPUT LEDs indicating the selected input port.
From left to right: BALANCED INPUTS - LINE 1, 2, 3
4. INPUT SOURCE SELECTOR push-button allows selection of amplifier channel used.

REAR PANEL

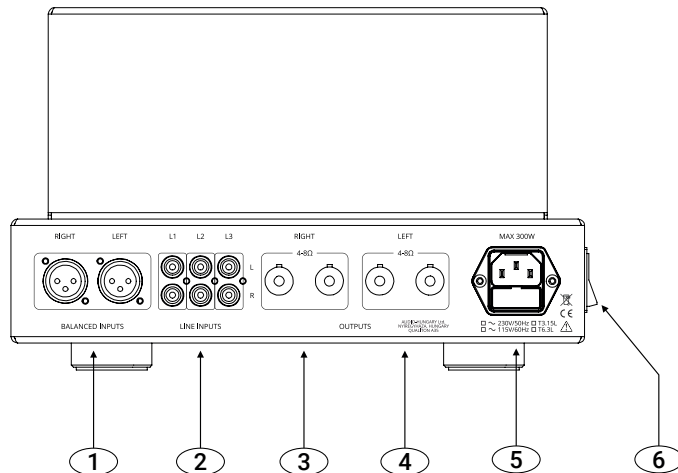

REAR PANEL

1. BALANCED INPUTS accept high level program source signals.
2. LINE 1, 2, and 3 INPUTS accept high level program source signals
3. RIGHT POWER OUTPUT - Connections for a 4 or 8 Ohm loudspeaker.
4. LEFT POWER OUTPUT - Connections for a 4 or 8 Ohm loudspeaker.
5. IEC Appliance AC INLET with built-in main fuse holder to connect the Qualiton A35 to a live AC outlet.
6. MAIN SWITCH with position indicator.

CONTENTS OF PACKAGE

Once you have unpacked the entire contents of the package, you can now check that you have received all the accessories.

- 1 pc Qualiton A35
- 1 pc Remote Control
- 1 pc User's Manual
- 4 pcs 7581A / 5881 power tubes
- 2 pcs 12AX7 / ECC83 vacuum tubes
- 2 pcs 6922 / E88CC vacuum tubes
- 1 pc Standard Mains Cable
- 1 pc Torx Wrench (TX10)

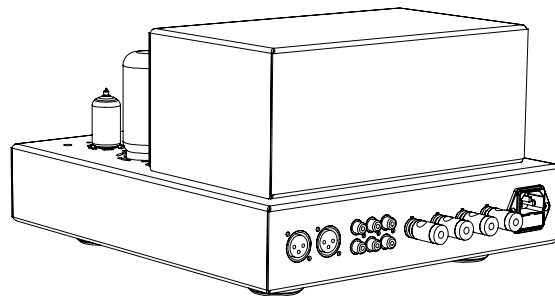

PLACEMENT

- Please read the following carefully to select a correct location for your amplifier.

- **IMPORTANT!** Due to the vacuum tube construction of the amplifier, it may heat up during use. Thus, choose a location for installation where the appliance can be well ventilated.

- The ventilation holes of the amplifier must not be covered (by tablecloth, curtain, newspaper, book, etc.). Impairing ventilation can lead to overheating and irregular operation conditions.

- Do not stack multiple units on top of each other.

- Avoid relocating the appliance from a cold to a warm environment. Sudden temperature changes can lead to moisture condensation. Please wait until moisture is evaporated before putting your amplifier into operation.

- The aforesaid applies to the very first installation of the amplifier as well. Prior to the first installation, leave the amplifier at its place of operation at least for 2 hours. Once this time is over, the amplifier can be powered up, according to this guide.

- The appliance is designed for indoor use. Do not operate it in wet, humid environment.

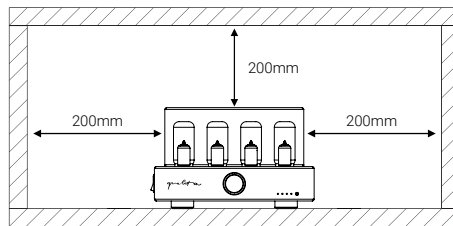

- Do not store any electrical device or object in a perimeter of 200 millimetres around your amplifier. Do not use the appliance next to heating sources and radiators. Keep it away from hot or dusty environment and flame.

INSTALLATION OF VACUUM TUBES

- You have to remove the protective cover to prepare for the insertion of the electron tubes. The protective cover locks in place with relatively high resistance, be careful not to scratch the device while removing it. See the figure below.
- Remove a power tube from one of the boxes labeled 7581A and carefully place it in one of the tube sockets labeled 7581A / 5881 in the figure below. Make sure that the position of the small 'key' on the bottom of the vacuum tube matches the position of the notch in the middle of tube socket and fits in it correctly. See the figure below.
- Repeat the same steps with the three remaining 7581A tubes. If all four power tubes are in place, the driver tubes may follow.
- Remove a tube from one of the boxes labeled 12AX7 and carefully place it in one of the tube sockets labeled 12AX7 / ECC83 in the figure below. Make sure that the holes in the electron tube socket fit the pins of the electron tube correctly. See the figure below.
- Repeat the previous step with the other 12AX7 tube.
- Remove a tube from one of the boxes labeled 6922 and carefully place it in one of the tube sockets labeled 6922 / E88CC in the figure below. Make sure that the holes in the electron tube socket fit the pins of the electron tube correctly. See the figure below.
- Repeat the previous step with the other 6922 tube.
- Carefully put the protective cover back in place. See the figure below.

INSTALLATION OF VACUUM TUBES

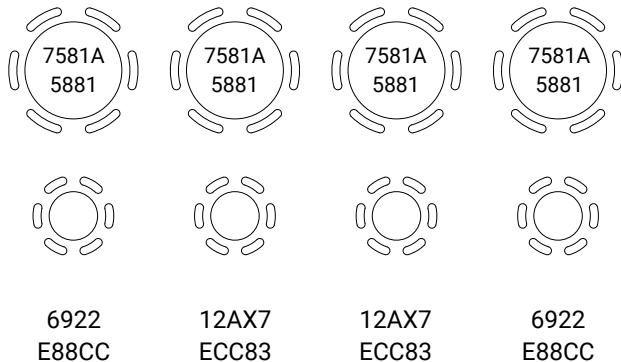
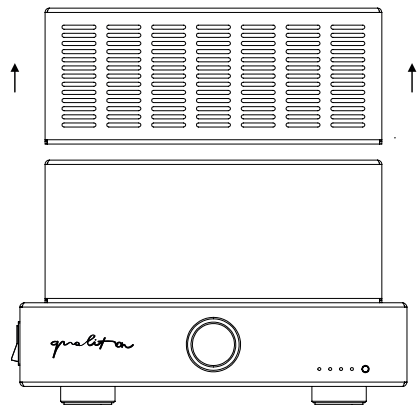

INSTALLATION OF VACUUM TUBES

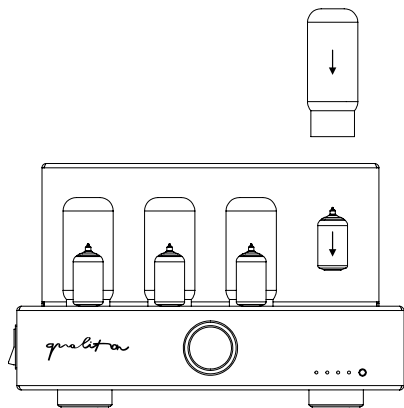

7581A / 5881

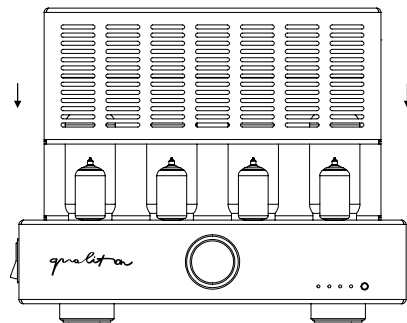
12AX7 / ECC83
6922 / E88CC

USING THIRD PARTY VACUUM TUBES

- Audio-Hungary Ltd. does not recommend the use of any other electron tubes in the A35 preamplifier other than those supplied with the device.
- Audio-Hungary Ltd. cannot and does not warrant against, and shall have no liability of any kind for any defects resulting from the use of vacuum tubes from third parties and such defects will void the warranty.

BLOCK DIAGRAM

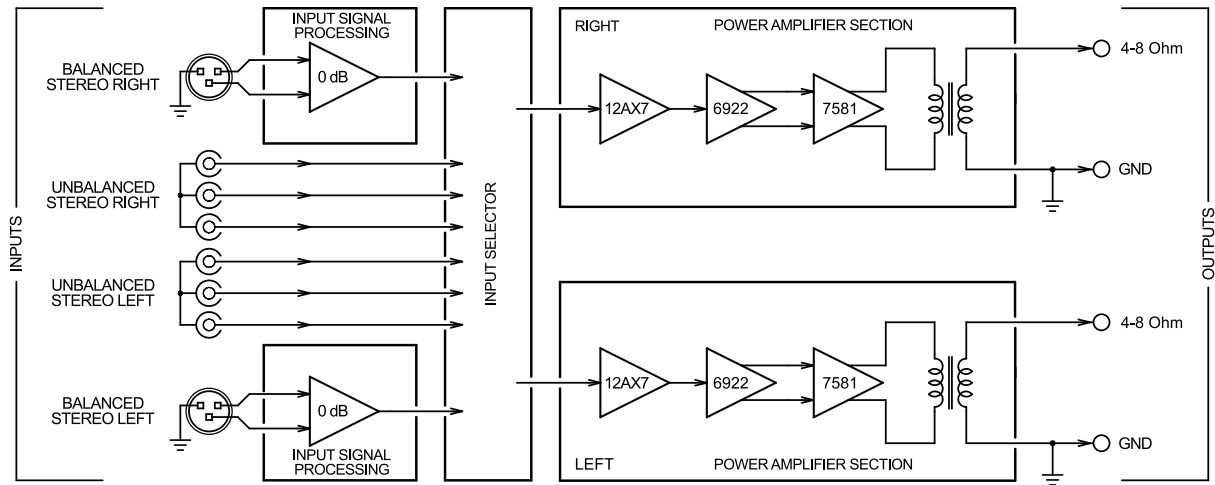

AC MAINS CONNECTION

- The Qualiton A35 is factory configured for one of the following AC Mains Voltages:

- ~ 115 V/60 Hz at Amps 6,3 AT
 - ~ 230 V/50 Hz at Amps 3,15 AT

- Make sure you want to operate the A35 at the AC mains voltage and frequency marked on the back.
- The standard IEC power inlet with fuse holder are placed on the rear panel.
- The amplifier is of Class 1 construction and must be connected to a mains socket outlet with a protective earthing connection.
- The appliance can be operated safely only with the supplied standard IEC mains cable.

WARNING! Do not connect any external source to the appliance until you have connected it to a mains socket outlet with a protective earthing connection.

GOOD TO KNOW

The Qualiton A35 features a sophisticated, fully automatic bias control system for the four power tubes. This circuit continuously monitors the behavior of each tube and regulates the bias voltages accordingly.

REMOTE CONTROL

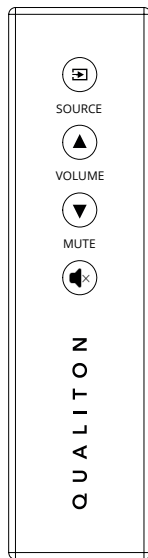

1. INPUT SOURCE SELECTOR

2. VOLUME UP

3. VOLUME DOWN

4. MUTE

INSERTING / REPLACING BATTERY

PLEASE NOTE: A35's remote control comes without battery. The remote control operates with type A23 battery. Battery should be installed by the user before first use:

1. Unscrew the screws on the back (a., b., c.) with the torx wrench, included in the package, then remove the cover. (d.)
2. Insert an A23 battery, as shown in the diagram.
3. Place back the cover and fasten it tightening the screws.

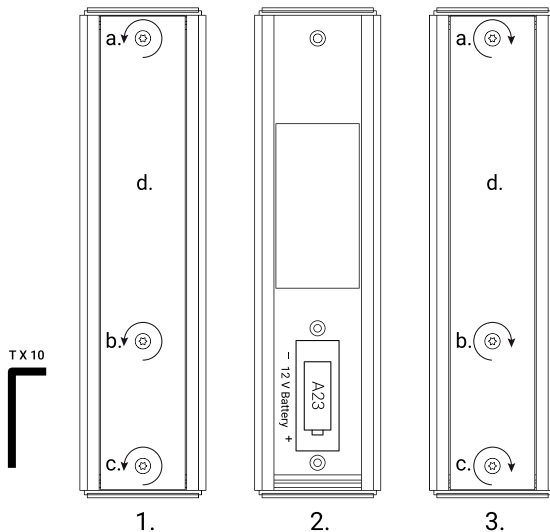

REPLACEMENT OF FUSE

The IEC power inlet features a built-in fuse holder. The specification of replacement fuses are: 3,15 AT for 230 V AC mains and 6,3 AT for 115 V AC mains.

1. Open the fuse holder with a screwdriver.
2. Change the used main fuse (b.) for the spare fuse (a.).

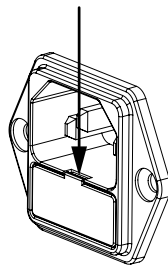

1.

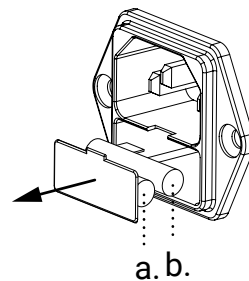

2.

WASTE MANAGEMENT

- The appliance and its packaging are made of recyclable materials.
- The appliance contains repairable or recyclable components and materials. Waste separation makes their recycling possible.
- A faulty appliance or an appliance meant to be discarded has to be sent or brought to an adequate waste collection place or to our company site.
- For further information on waste disposal please contact our company or local authorities.



Audio-Hungary Ltd. Hungary
132 Derkovits Street 4400 Nyíregyháza

WWW.AUDIOHUNGARY.COM